

MotorGuide®

8M0119779 1216 eng



Operation Maintenance Installation Warranty Manual

Pinpoint GPS

© 2017 Mercury Marine

ORIGINAL LANGUAGE INSTRUCTIONS

FCC and IC Compliance Statement

PINPOINT WIRELESS REMOTE, FCC ID - MVU10148

IC: 6094A-10148

This device complies with part 15 of the FCC Rules. Operation is subject to the following two conditions:

1. This device may not cause harmful interference.
2. This device must accept any interference received including interference that may cause undesired operation.

Changes or modifications not expressly approved by the party responsible for compliance could void the user's authority to operate the equipment.

This device complies with Industry Canada license-exempt RSS standard(s). Operation is subject to the following two conditions: (1) this device may not cause interference, and (2) this device must accept any interference, including interference that may cause undesired operation of the device.

Le présent appareil est conforme aux CNR d'Industrie Canada applicables aux appareils radio exempts de licence. L'exploitation est autorisée aux deux conditions suivantes: (1) l'appareil ne doit pas produire de brouillage, et (2) l'utilisateur de l'appareil doit accepter tout brouillage radioélectrique subi, même si le brouillage est susceptible d'en compromettre le fonctionnement.



N2523

EU Compliance Statement

Attwood Corporation hereby declares that the MotorGuide Pinpoint GPS System is in compliance with the essential requirements and other relevant provisions of the 99/5/EC R&TTE directive.

CE Declaration

Manufacturer: **Attwood Corporation**

Address: 1016 N. Monroe

Lowell, MI 49331 USA

Telephone: 616-897-9241

Authorized Representative: **Brunswick Marine**

Parc Industriel de Petit-Rechain

B-4800

Verviers, Belgium

Telephone: +32(0)87323222

Product: **MotorGuide Xi5 Series**

Model: includes all 12, 24, and 36  volt DC models

Council Directive 1999/5/EC - Radio and Telecommunications Terminal Equipment (R&TTE)

- **EN 300 440-1 V1.6.1:** EMC and Radio spectrum Matters; Short Range Devices.
- **EN 301 489-1 V1.9.2:** EMC and Radio spectrum Matters; Radio Equipment.

Council Directive 2004/40/EC - Health and Safety Requirements

- **EN 62311:2008** - Assessment of electronic and electrical equipment related to human exposure restrictions for electromagnetic fields.

Council Directive 2004/108/EC - Electromagnetic Compatibility

- **EN 55012:2008; A1:2010** - Vehicles, boats and internal combustion engines.

Council Directive 98/96/EC - Maritime Equipment Directive

- **EN 60945:2002+C1:2008** - Maritime navigation and radiocom. equip. (Motor systems)
 - CISPR16 - Conducted and Radiated Emissions
 - EN61000-4-2:2008 ESD
 - EN61000-4-3:2006 Radiated Immunity
 - EN61000-4-4:2004 EFT
 - EN61000-4-5:2005 Surges
 - EN61000-4-6:2008 Conducted Susceptibility
 - EN61000-4-8:2001 Magnetic Field Immunity
 - EN61000-4-11:2004 Voltage Dips and Interrupts

Council Directive 2006/42/EC - Machinery

- **EN ISO 12100** - Safety of machinery - General principles for design, risk assessment and reduction

An official copy of the Declaration of Conformity can be found at <http://www.motorguide.com/support/certifications>.

Environmental Compliance Statement

All MotorGuide products that are subject to the 2002/96/EC WEEE directive are compliant with the WEEE marking requirement. Such products are marked with the crossed-out wheelie bin (WEEE symbol shown below) in accordance with European Standard EN50419.



54539

The symbol on the product or its packaging indicates that this product must not be disposed of with your other household waste. Instead, it is your responsibility to dispose of your waste equipment by handing it over to a designated collection point for the recycling of waste electrical and electronic equipment. The separate collection and recycling of your waste equipment at the time of disposal will help conserve natural resources and ensure that it is recycled in a manner that protects human health and the environment. For more information about where you can drop off your waste for recycling, please contact your local authority, or where you purchased your product.

Important Operator Information



ISO 7000-0434B - Caution symbol

Consult this documentation in all cases where this symbol appears. This symbol is used to inform you of any potential HAZARD or actions that require your attention.

Use of this equipment in a manner other than that specified by Attwood Corporation may compromise the design integrity and become unsafe.

WARNING: This equipment is not intended for use in explosive environments.

ADVERTENCIA: Este equipo no está diseñado para uso en atmósferas explosivas.

AVVERTIMENTO: Questa apparecchiatura non è inteso per l'uso in ambienti esplosivi.

WARNUNG: Das Ausrüstung darf in einer explosiven Umgebung NICHT verwendet werden.

ADVERTISSEMENT: Cet équipement n'est pas prévu pour une utilisation des environnements explosifs.

Thank You

Thank you for purchasing the MotorGuide Pinpoint GPS Navigation System.

The Pinpoint GPS Navigation System is designed to enhance the precision control and functionality of your MotorGuide trolling motor. We're confident that the Pinpoint GPS will enhance your fishing experience and we appreciate that you chose MotorGuide.

Warranty Message

The product you have purchased comes with a **Limited Warranty** from MotorGuide. The terms of the policy are set forth in the **MotorGuide Two Year Limited Warranty** section of this manual. The policy statement contains a description of the duration of coverage, **important disclaimers and limitations of damages**, and other related information. Please review this important information.

The description and specifications contained herein were in effect at the time this manual was approved for printing. MotorGuide, whose policy is one of continued improvement, reserves the right to discontinue models at any time, to change specifications, designs, methods, or procedures without notice and without incurring obligation.

MotorGuide, Lowell, Michigan U.S.A.

Mercury Marine

Eagle and Lowrance are registered trademarks of Navico Inc. Garmin is a registered trademark of Garmin Ltd. Humminbird is a registered trademark of Johnson Outdoors Marine Electronics, Inc. Vexilar is a registered trademark of Vexilar, Inc.

Copyright and Trademark Information

© MERCURY MARINE. All rights reserved. Reproduction in whole or in part without permission is prohibited.

Alpha, Axius, Bravo One, Bravo Two, Bravo Three, Circle M with Waves Logo, K-planes, Mariner, MerCathode, MerCruiser, Mercury, Mercury with Waves Logo, Mercury Marine, Mercury Precision Parts, Mercury Propellers, Mercury Racing, MotorGuide, OptiMax, Quicksilver, SeaCore, Skyhook, SmartCraft, Sport-Jet, Verado, VesselView, Zero Effort, Zeus, #1 On the Water and We're Driven to win are registered trademarks of Brunswick Corporation. Pro XS is a trademark of Brunswick Corporation. Mercury Product Protection is a registered service mark of Brunswick Corporation.

Warranty Information

MotorGuide Two Year Limited Warranty.....	1
Transfer of Warranty United States and Canada.....	3

Product Installation and Operation

Installing the Pinpoint GPS Modules.....	4
Operating the Pinpoint GPS System.....	17
Connecting the Pinpoint GPS System to Your Fish Finder.....	34

Maintenance and Storage

Trolling Motor Care.....	35
Inspection and Maintenance Schedule.....	35
Storage Preparation.....	37
Battery Inspection.....	38

Owner Service Assistance

Frequently Asked Questions and Troubleshooting.....	39
Service Assistance.....	40
Mercury Marine Service Offices.....	40

WARRANTY INFORMATION

MotorGuide Two Year Limited Warranty

KEEP YOUR ORIGINAL PURCHASE RECEIPT OR BILL OF SALE.

1. For recreational use customers, Pinpoint GPS components are warranted to a retail purchaser and subsequent recreational use customers to be free from defects in material or workmanship for a period of two years from the date of purchase.
2. To obtain warranty service, the purchaser should deliver or return the unit (postage prepaid and insured) to any MotorGuide authorized service dealer. **DO NOT RETURN TO PLACE OF PURCHASE** unless they are an authorized service center. Products returned by mail should be carefully packaged and include a note describing the nature of the problem and/or service requested, customer address, and phone number. A copy of the receipt, bill of sale, registration verification or other proof of purchase is required with the return of the product for warranty consideration. Warranty claims will not be accepted without presentation of purchase receipt for the trolling motor, other verification of registration, or bill of sale for a boat package.
3. MotorGuide, at its discretion, will repair or replace items covered under the terms of this warranty. Neither MotorGuide nor MotorGuide service dealers are responsible for damages to MotorGuide products due to repairs performed by anyone other than an authorized MotorGuide service dealer. Neither MotorGuide nor Attwood is responsible for failure or damage caused by improper installation, set-up, preparation, or previous service or repair errors.
4. For commercial use and government use customers, Pinpoint GPS components are warranted to the original retail purchaser to be free from defects in material or workmanship for one (1) year. Commercial use is defined as any work or employment-related use of the product, or any use of the product which generates income, for any part of the warranty period, even if the product is only occasionally used for such purpose such as rental fleets, guides, fish camps or similar operations. Warranty is not transferable to any subsequent purchaser. The Mercury Product Protection plan is not available to commercial use or government use customers.

WARRANTY INFORMATION

5. Warranty coverage is available to customers that purchase from an authorized dealer or retailer that is authorized by MotorGuide to distribute the product in the country in which the sale occurred, and subsequent owners of the product during the Limited Warranty period. Warranty coverage and duration varies by the country in which the owner resides. This Limited Warranty begins on the date the product is first sold to a purchaser or the date on which the product is first put into service, whichever occurs first. The repair or replacement of parts, or the performance of service under this warranty, does not extend the life of this warranty beyond its original expiration date. Promotional warranties are not included in this statement and coverage may vary by promotion. Product either sold or put into service more than six years from date of manufacture is excluded from warranty coverage.
6. We reserve the right to improve the design of any trolling motor or accessory without assuming any obligation to modify any trolling motor or accessory previously manufactured.
7. This warranty will not apply to: 1) haul-out, launch, towing and storage, transportation charges and/or travel time, telephone or rental charges of any type, inconvenience, or loss of time or income, or other consequential damages; or 2) removal or replacement of boat partitions or material because of boat design for necessary access to the Product; or 3) disconnection and reconnection of hard-wired trolling motors.
8. **TERMINATION OF COVERAGE:** Warranty coverage may be terminated for repossessed product, or product purchased at auction, from a salvage yard, from a liquidator, from an insurance company, from unauthorized marine dealers or boatbuilders, or other third party entities.
9. **ALL INCIDENTAL OR CONSEQUENTIAL DAMAGES ARE EXCLUDED FROM THIS WARRANTY, WARRANTIES OF MERCHANTABILITY AND FITNESS ARE EXCLUDED FROM THIS WARRANTY, IMPLIED WARRANTIES ARE LIMITED TO THE LIFE OF THIS WARRANTY. SOME STATES DO NOT ALLOW LIMITATIONS ON HOW LONG AN IMPLIED WARRANTY LASTS OR THE EXCLUSION OR LIMITATION OF INCIDENTAL OR CONSEQUENTIAL DAMAGES, SO THE ABOVE LIMITATIONS OR EXCLUSIONS MAY NOT APPLY TO YOU. THIS WARRANTY GIVES YOU SPECIFIC LEGAL RIGHTS, AND YOU MAY ALSO HAVE OTHER LEGAL RIGHTS WHICH MAY VARY FROM STATE TO STATE.**

For your records:

- Model number _____
- Serial number _____

WARRANTY INFORMATION

Transfer of Warranty United States and Canada

The limited warranty is transferable to a subsequent purchaser, but only for the remainder of the unused portion of the limited warranty. This will not apply to products used for commercial or government applications.

To transfer the warranty to the subsequent owner, send or fax a copy of the bill of sale or purchase agreement, new owner's name, address, and engine serial number to Mercury Marine's warranty registration department. In the United States and Canada, mail to:

Mercury Marine
Attn: Warranty Registration Department
W6250 Pioneer Road
P.O. Box 1939
Fond du Lac, WI 54936-1939
920-929-5054
Fax +1 920 907 6663

Upon processing the transfer of warranty, Mercury Marine will record the new owner's information.

There is no charge for this service.

OUTSIDE THE UNITED STATES AND CANADA

For products purchased outside the United States and Canada, contact the distributor in your country, or the Mercury Marine Service Office closest to you.

PRODUCT INSTALLATION AND OPERATION

Installing the Pinpoint GPS Modules

⚠ WARNING

Before working around electrical system components, disconnect the battery cables from the battery to prevent injury or damage to the electrical system due to an accidental short circuit.

1. Starting with the negative (-) lead, disconnect the trolling motor battery cables from the battery, or unplug the trolling motor from the boat's power receptacle.
2. Remove the five screws from under the trolling motor head. Remove the cover from the trolling motor head.

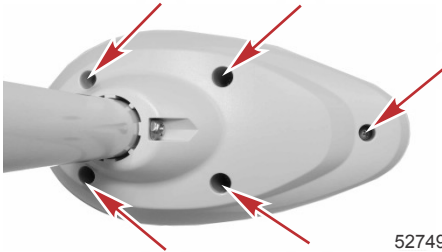

Screw locations—under trolling motor head

3. Remove the cable grommet from the trolling motor head.

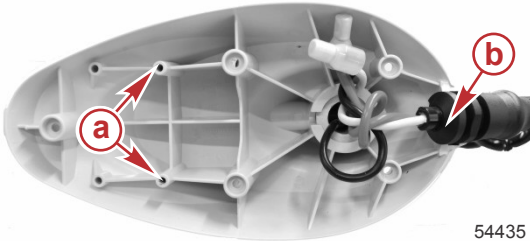

- a** - GPS module mounting holes
- b** - Cable grommet

PRODUCT INSTALLATION AND OPERATION

- Place the upper GPS module into the trolling motor head as shown, with the GPS cable exiting the module from below. Secure the upper GPS module to the trolling motor head with two mounting screws. Push the power wires to one side to ease installation of the GPS cable. Route the GPS cable out of the trolling motor head, through the slot in the cable grommet as shown.

NOTE: The cable grommet is molded to allow the GPS cable to be routed under it.

IMPORTANT: Ensure that the GPS module is installed with the cable exiting the module from below. Verify that the orientation of the GPS module matches the photo. GPS will not function if the module is installed upside down.

IMPORTANT: Do not overtighten the mounting screws or use power tools to tighten the screws.

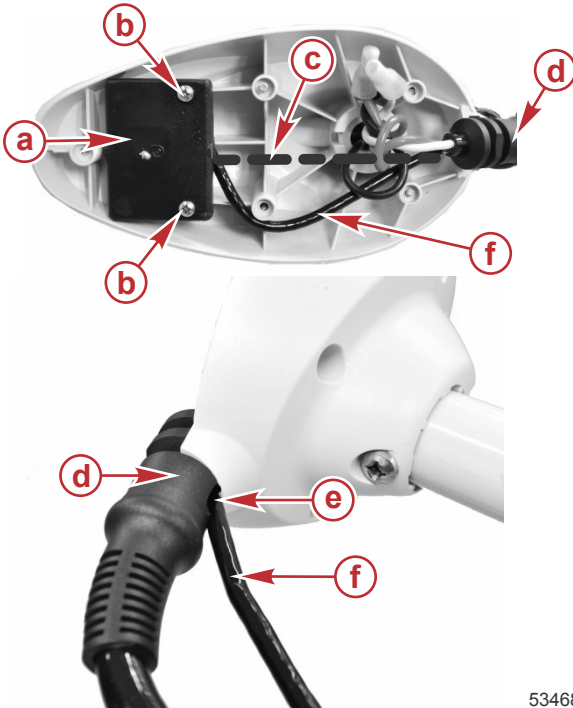

53468

- a - Upper GPS module
- b - Mounting screws (2)
- c - Incorrect GPS cable routing—do not install the cable here
- d - Cable grommet
- e - Unused slot for sonar cable
- f - GPS cable—correct routing

PRODUCT INSTALLATION AND OPERATION

5. Place the cover onto the trolling motor head. Ensure that the cable grommet is seated in the trolling motor head and that no wires are pinched. Install the five screws that secure the cover to the trolling motor head.

IMPORTANT: Do not overtighten the screws or use power tools to tighten the screws.

6. Extend the trolling motor column so that the coiled power cable is as long as possible. Starting from the trolling motor head, wrap the coiled GPS cable around each coil of the power cable until you reach the lower mount. This will place the coiled GPS cable inside the coils of the power cable.

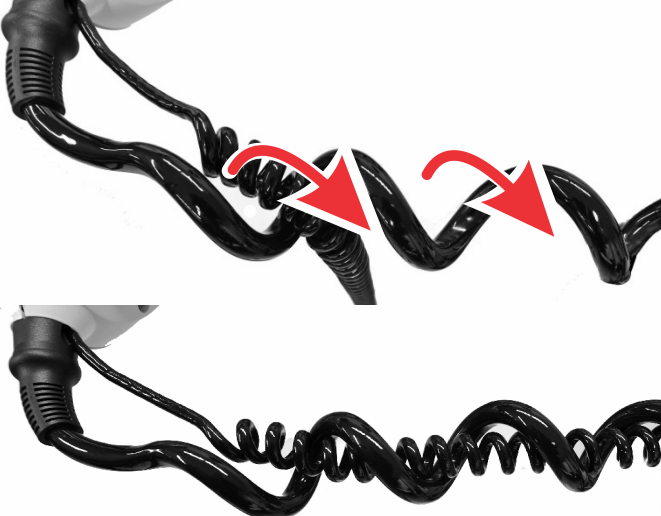

54436

PRODUCT INSTALLATION AND OPERATION

7. Remove the side panel screws from each side of the trolling motor. Gently pull the side panels away from the mount, taking care not to damage the locating tabs, and remove the side panels from both sides of the trolling motor.

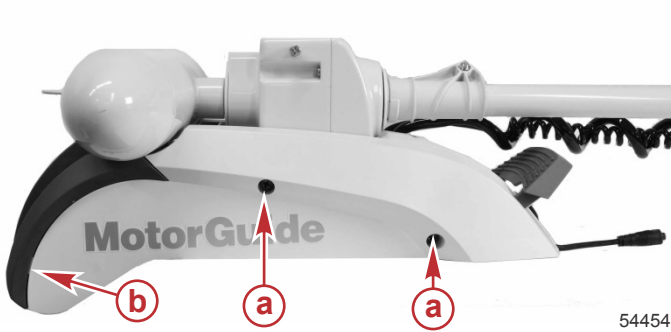

- a** - Side panel screws
- b** - Locating tab

8. Remove the plastic plug from the trolling motor base.

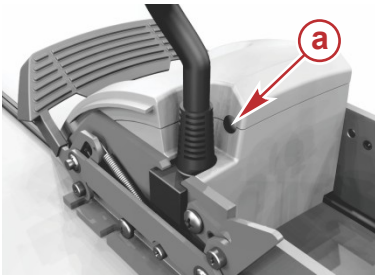

- a** - Plastic plug

9. Remove the status indicator light panel from the trolling motor by lifting it up, then rotating it to clear the foot release lever. Do not unplug the status indicator light panel from the trolling motor.

PRODUCT INSTALLATION AND OPERATION

NOTE: If you unplug the status indicator light panel, ensure that you reinstall the connector with all of the pins inserted into the ribbon cable connector. The panel will not function if the connector is not correctly installed.



10. Install the lower GPS module into the empty slot in the trolling motor base in the following order:

- Place the lower GPS module gently into the empty slot. Route the NMEA cable through the slots as shown, with the connector exiting the trolling motor base.

NOTE: If the NMEA cable will not be used, it can be coiled and left inside the trolling motor base.

- Remove the cap from the female GPS connector.
- Route the male GPS connector through the slot, and connect it to the female GPS connector by aligning the pins and locating tabs in the connectors. Press the connectors together, then turn the nut 1/4 turn to the right until it locks.
- Gently press the lower GPS module into the opening until it is fully seated.

PRODUCT INSTALLATION AND OPERATION

- Route the GPS cable through the opening in the trolling motor base.

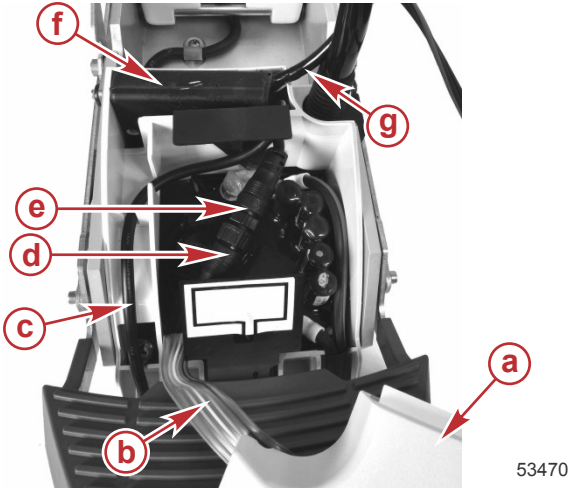

- a** - Status light indicator panel
- b** - Status light harness
- c** - NMEA cable
- d** - Female GPS connector
- e** - Male GPS connector
- f** - Lower GPS module
- g** - GPS cable

- Inspect the circuit board for presence of dielectric grease over all connections. If the dielectric grease is not present, apply dielectric grease to all connections prior to installing the status indicator light panel.

PRODUCT INSTALLATION AND OPERATION

11. Install the status indicator light panel. Ensure that no wires are pinched between the status indicator light panel and the trolling motor, and that the GPS cable is positioned as shown.

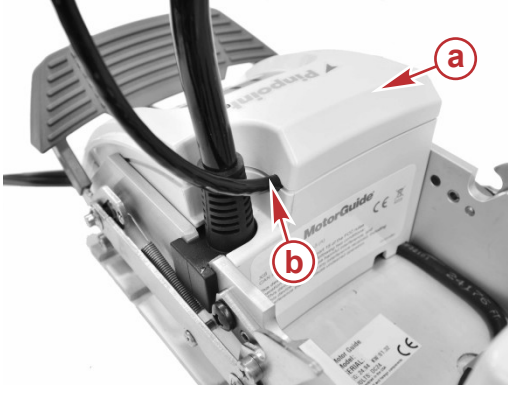

54438

- a** - Status indicator light panel
- b** - GPS cable

12. Install the side panels onto the trolling motor. Ensure that the status indicator light panel is seated between the side panels as shown, and that no wires are pinched.

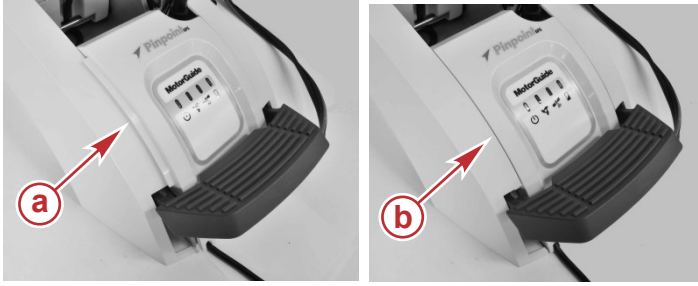

54529

- a** - Status indicator light panel not seated—incorrect
- b** - Status indicator light panel seated between side panels—correct

PRODUCT INSTALLATION AND OPERATION

13. Ensure that no wires are pinched between the side panels and the trolling motor. Tighten the side panel mounting screws.

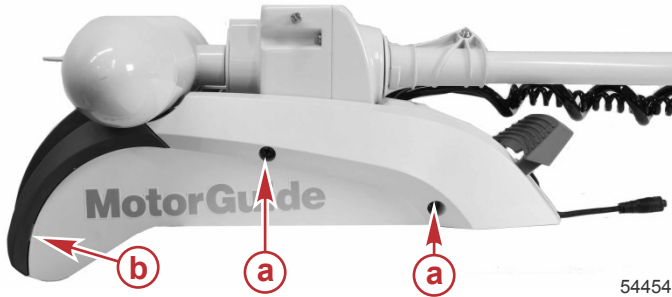

- a - Side panel screws
- b - Locating tab

TROLLING MOTOR INSTALLATION GUIDELINES

IMPORTANT: Refer to the MotorGuide Xi5 Operation, Maintenance, Installation, and Warranty manual included with your MotorGuide Xi5 trolling motor for complete installation instructions.

This section covers important guidelines when installing a Pinpoint GPS system into your MotorGuide Xi5 trolling motor. Trolling motor installation instructions can be found in the **MotorGuide Xi5 Operation, Maintenance, Installation, and Warranty** manual. Refer to the following list of important considerations:

- Verify that objects containing iron (such as anchors) are not located within 91.4 cm (36 in.) of the trolling motor.
- Keep unnecessary wiring and power cables away from the trolling motor.
- Verify that the trolling motor power cables are bundled together. Do not route the power cables separately, particularly within 91.4 cm (36 in.) of the trolling motor. Routing the power cables together reduces electromagnetic interference.
- Obstructions such as mountain ranges, bridges, tall trees, buildings, and severe weather can affect the GPS signal strength.
- GPS signal strength can be affected by certain geographic locations, such as southern or northern polar extremes like Alaska and northern Canada.

PRODUCT INSTALLATION AND OPERATION

⚠ CAUTION

Avoid injury or property damage due to unintended operation. Certain objects—especially magnetic metal objects, such as anchors—can affect the GPS system if they are within or passing through the magnetic field surrounding the trolling motor. Objects obstructing the GPS signal can also have a negative effect on system operation. Be mindful of objects close to the trolling motor, and use care when operating the trolling motor in a GPS-guided mode.

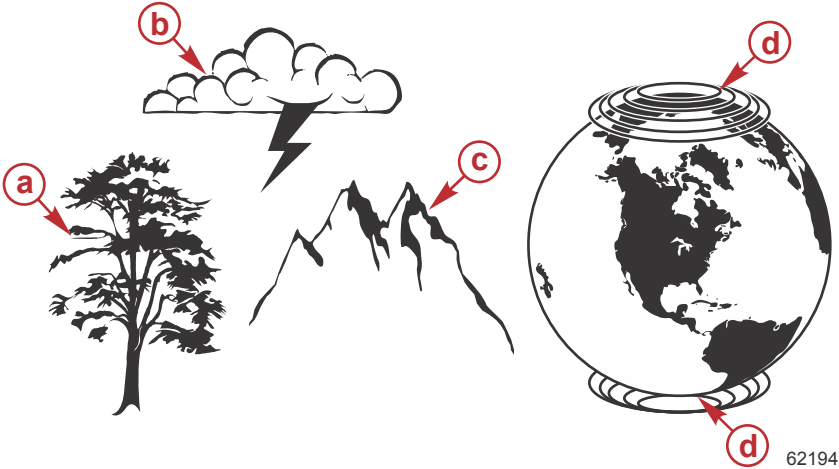

Objects and locations may obstruct the GPS signal

- a** - Trees
- b** - Severe weather
- c** - Mountains
- d** - Extreme Northern and Southern locations

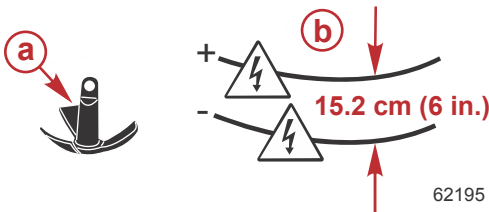

Objects may cause disturbance to the magnetic field within 91 cm (36 in.) of the trolling motor

- a** - Objects containing iron (such as anchors)
- b** - Trolling motor power cables (install no more than 15.2 cm [6 in.] apart)

PRODUCT INSTALLATION AND OPERATION

LINKING THE HANDHELD REMOTE TO THE TROLLING MOTOR

The first time the trolling motor is powered up, the handheld remote will need to be linked to the trolling motor. The linking procedure is listed as follows:

1. Deploy the trolling motor.
2. Starting with the positive (+) lead, connect the trolling motor power cables to the battery.
3. Within ten seconds after connecting the power cables, press and hold the **left arrow** button and **right arrow** button on the handheld remote at the same time. The trolling motor will emit a low tune to confirm that the handheld remote has been linked to the trolling motor.

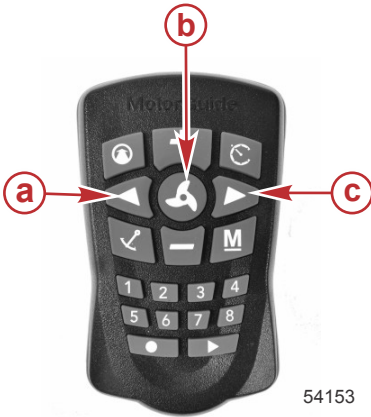

- a - Left arrow button
- b - Propeller button
- c - Right arrow button

If you wish to clear the linked handheld from the trolling motor's memory, connect the battery cables to a power source such as the trolling motor battery or power receptacle, and in less than ten seconds press the **left arrow**, **right arrow**, and **propeller** buttons at the same time. You will need to complete the link procedure again to use the handheld remote with the trolling motor.

If you are having trouble syncing your remote, start with the motor unplugged and deployed. Hold down the **left arrow**, **right arrow**, and **propeller** buttons at the same time before you plug in the motor. Once the battery light turns green, let go of the buttons and the link process should be complete.

PRODUCT INSTALLATION AND OPERATION

MOUNTING ANGLE CALIBRATION

IMPORTANT: This calibration is required and must be completed when the GPS modules are installed. It should be repeated when the trolling motor is moved from one boat to another. This calibration can be done with the boat in or out of the water.



- a - Left turn
- b - Right turn
- c - Manual mode
- d - #2 button
- e - #1 button

IMPORTANT: A fixed GPS position is required to complete the mounting angle calibration. The Pinpoint GPS system will emit an audible tune once it has acquired a fixed GPS position (in the default audio mode), and the GPS status indicator light will illuminate.

1. Power up and deploy the trolling motor. Adjust the motor height so that the motor is clear of any obstructions while turning.

IMPORTANT: Stay a safe distance away from the propeller—the trolling motor is in an operational mode.

⚠ WARNING

Rotating propellers can cause serious injury or death. Never start or operate the motor out of water.

PRODUCT INSTALLATION AND OPERATION

2. Use the **left turn** and **right turn** buttons to steer the unit so that it is facing straight ahead, parallel with the keel of the boat, with the nose cone of the lower unit facing forward and the propeller facing aft.

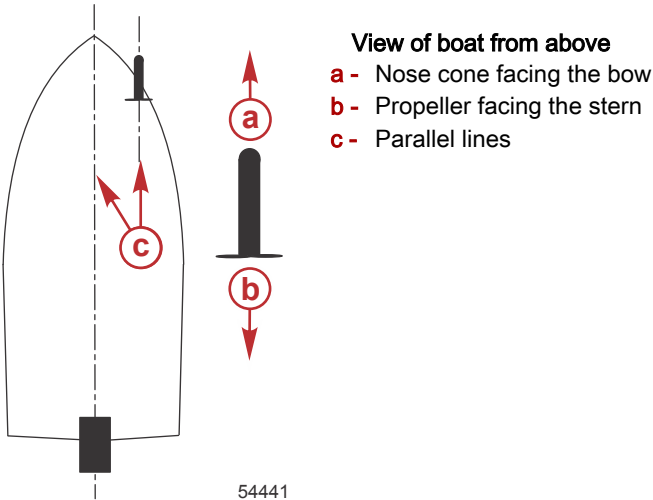

3. Once the lower unit is positioned as close to parallel with the keel as possible, press and hold the **manual mode** button, then press and release the **1**, **1**, then **2** buttons in sequence. The trolling motor will emit an audible tune, flash the status indicator light, and then return to manual mode, completing the mounting angle calibration.

COMPASS CALIBRATION

IMPORTANT: This calibration is completed at the factory. It should be repeated at the time of installation, if the Pinpoint GPS system is not performing as expected, or if you have travelled a long distance from the last point of calibration. This calibration may be done with the boat in the water using the primary propulsion engine, or with the boat on the trailer. If the boat is on the trailer, tow the boat in two circles. Two beeps will occur when very close to completing the second circle. Listen for the tone to acknowledge a successful calibration. The GPS light will turn off after command M111 is accepted. The GPS light will turn on and a beep will occur, signalling a successful calibration.

IMPORTANT: A fixed GPS position is required to complete the compass calibration. The Pinpoint GPS system will emit an audible tune once it has acquired a fixed GPS position (in the default audio mode), and the GPS status indicator light will illuminate.

PRODUCT INSTALLATION AND OPERATION

IMPORTANT: GPS single strength may vary, depending on satellite reception. This can affect GPS performance.

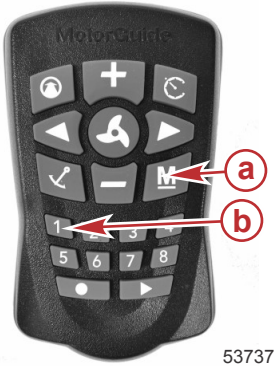

- a - Manual mode
- b - #1 button

1.
 - a. **If performing the compass calibration with the boat in the water:** locate a suitable area clear of obstructions to navigation (both above and below the waterline) to perform the compass calibration.
 - b. **If performing the compass calibration with the boat on the trailer:** locate a suitable area clear of obstructions to perform the compass calibration.
2. Deploy the trolling motor. If performing the compass calibration with the boat in the water, verify that you are in a location where your trolling motor and primary propulsion engine will not hit bottom or other obstructions.
3. Press and hold the **manual mode** button, then press **1, 1, 1**. The trolling motor will emit three ascending-tone beeps and the GPS status indicator light will turn off.
4.
 - a. **If performing the compass calibration with the boat in the water:** use the primary propulsion engine to slowly drive the boat in two complete circles.
 - b. **If performing the compass calibration with the boat on the trailer:** tow the boat in two complete circles.
5. Two beeps will occur when very close to completing the second circle. The GPS status indicator light will turn on and a beep will occur, signalling a successful compass calibration.

RESET TO FACTORY CALIBRATION

To reset the trolling motor to the factory calibration, press and hold the **manual mode** button, then press **1, 1, 4**.

PRODUCT INSTALLATION AND OPERATION

Operating the Pinpoint GPS System

STATUS INDICATOR LIGHT IDENTIFICATION

This trolling motor is equipped with a multifunction status indicator light panel. It can display the status of the motor, propeller, battery charge, and GPS status for quick and easy reference during operation.

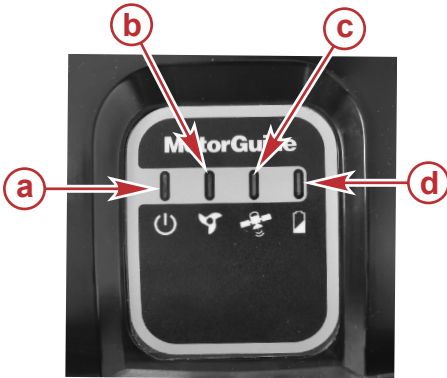

- a** - Power on/off indicator light
- b** - Propeller on/off indicator light
- c** - GPS navigation indicator light
- d** - Battery status light

51836

PINPOINT GPS STARTUP

The global positioning system (GPS) is a satellite-based navigation system capable of providing positional information anywhere on Earth, provided that the GPS receiver has a clear line of sight to at least four GPS satellites.

When the trolling motor is powered up and deployed, it is immediately capable of operating as a conventional trolling motor. The trolling motor will require between 30 seconds to 10 minutes to acquire a fixed GPS position, depending on how much time has passed since the unit was powered up. Having a clear view of the sky overhead, with no large trees, power lines, bridges, mountain ranges, or buildings to interfere with the GPS signal, will improve the GPS accuracy and reduce the amount of time required to obtain a fixed GPS position. Once the unit has acquired a fixed GPS position, the GPS accuracy will continually improve for several minutes. It is recommended to power up the trolling motor as soon as possible before operation to allow the fixed GPS position to become as accurate as possible.

Power up the trolling motor by connecting the battery cables to the trolling motor batteries, or plugging the trolling motor into the trolling motor power plug (if equipped). The trolling motor will emit audio signals to make the operator aware of its status.

- The trolling motor will emit one beep when it is powered up.
- The trolling motor will emit a three-beep tune once it has acquired a fixed GPS position, and the GPS status indicator light will illuminate.

PRODUCT INSTALLATION AND OPERATION

NOTE: Areas near the North and South poles, remote Northern areas, bridges, severe weather, mountain ranges, and other large obstructions may affect the GPS signal strength.

OPERATING IN MANUAL MODE

In manual mode, the trolling motor operates like a conventional trolling motor. It allows the operator to manually control the direction of travel and thrust level of the trolling motor, using the directional controls on the handheld remote or wireless foot pedal. Refer to the following illustration and instructions to operate the trolling motor in manual mode with the handheld remote.

Once the trolling motor is powered up, it is ready to operate in manual mode. Manual mode is the default mode after power-up, and also if the GPS signal is lost while in a GPS operating mode. If the GPS signal is lost, the GPS indicator light will turn off. The trolling motor will emit one beep to indicate its status in manual mode. To enter manual mode from another mode, press the **manual mode** button.



Turning the Handheld Remote On or Off

The handheld remote is always on, and is ready for use anytime that the trolling motor is powered up and in the deployed position.

Steering

- To turn left, press the **left turn** button on the handheld remote.
- To turn right, press the **right turn** button on the handheld remote.
- The available steering range allows the trolling motor to turn beyond 180° for operation in reverse.

Speed Control

- Press the **propeller on/off** button once to start the propeller, and press the **propeller on/off** button again to stop the propeller.
- The trolling motor will emit a two-beep tone when the propeller is started, and the propeller status indicator light on the trolling motor will illuminate.

PRODUCT INSTALLATION AND OPERATION

- The trolling motor will emit a two-beep tone when the propeller is stopped, and the propeller status indicator light will turn off.
- The system is equipped with 20 speed levels. Press the **increase speed (+)** button to increase motor speed by one level, and press the **decrease speed (-)** button to reduce the motor speed by one level.
- Holding the **increase speed (+)** or **decrease speed (-)** buttons will cause the speed level to increase or decrease until the speed level is reached. Holding the **increase speed (+)** or **decrease speed (-)** button for 2.5 seconds will increase the speed level from 0% to 100%, or decrease from 100% to 0%, respectively. The trolling motor will emit a two-beep tone when it reaches the 100% or 0% speed level.
- The trolling motor will emit a two-beep tone if the user tries to increase or decrease the motor speed beyond its limits.

OPERATING IN ANCHOR MODE

Anchor Mode

Anchor mode allows the boat's bow to remain in a fixed location, and will automatically account for wind and current changes to keep the boat in the selected location, using the trolling motor steering and speed controls. In order for anchor mode to operate, the Pinpoint GPS system must have achieved a fixed GPS location, indicated by the trolling motor emitting a three-beep tone, and the GPS status indicator light will illuminate.

WARNING

Avoid serious injury from colliding with other boats, running aground, or striking objects in the water. The Pinpoint GPS system cannot detect other boats, shallow water, or objects in the water. Always beware of possible obstructions to navigation when operating in any Pinpoint GPS mode.

PRODUCT INSTALLATION AND OPERATION

▲ WARNING

A spinning propeller, a moving boat, or any solid device attached to the boat can cause serious injury or death to swimmers. Stop the trolling motor immediately whenever anyone in the water is near your boat.



- a - Anchor mode
- b - Manual mode

53018

▲ CAUTION

Avoid injury or property damage due to unintended operation. Certain objects—especially magnetic metal objects, such as anchors—can affect the GPS system if they are within or passing through the magnetic field surrounding the trolling motor. Objects obstructing the GPS signal can also have a negative effect on system operation. Be mindful of objects close to the trolling motor, and use care when operating the trolling motor in a GPS-guided mode.

Setting the Anchor

Press the **anchor mode** button to place the system in anchor mode. When the **anchor mode** button is pressed, the system will lock onto the fixed GPS position at the moment that the button was pressed. The trolling motor will emit one ascending chirp to indicate its status in anchor mode, and the GPS status indicator light will blink slowly.

While anchor mode holds the boat in the selected position, the boat may rotate or pivot around the trolling motor's steering axis. The orientation of the boat will follow the wind and/or current.

Exiting Anchor Mode

Press the **anchor mode** button again or press the **manual mode** button. The trolling motor will emit a descending chirp and the GPS status indicator light on the trolling motor will stop blinking and remain on.

PRODUCT INSTALLATION AND OPERATION

Adjusting the Anchor Position

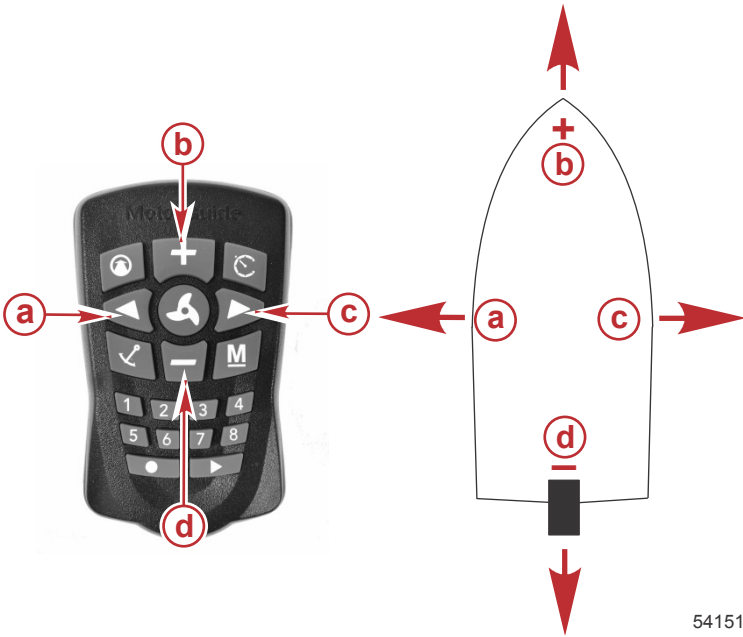

54151

- a** - Left turn—"jog" left
- b** - Increase speed—"jog" ahead
- c** - Right turn—"jog" right
- d** - Decrease speed—"jog" behind

Once the trolling motor is in anchor mode, the anchor position can be adjusted by pressing the **left turn**, **right turn**, **increase speed (+)**, or **decrease speed (-)** buttons. Pressing any of these buttons once will adjust the anchor position by five feet in the direction selected, relative to the boat's heading. For example, pressing the + button once will move the anchor position forward of the bow by five feet.

⚠ CAUTION

Avoid injury or property damage due to unintended operation. Certain objects—especially magnetic metal objects, such as anchors—can affect the GPS system if they are within or passing through the magnetic field surrounding the trolling motor. Objects obstructing the GPS signal can also have a negative effect on system operation. Be mindful of objects close to the trolling motor, and use care when operating the trolling motor in a GPS-guided mode.

PRODUCT INSTALLATION AND OPERATION

NOTE: Pressing a button multiple times will move the anchor position five feet for each time the button is pressed.

Storing or Overwriting an Anchor Position



a - Memory buttons (1–8)

NOTE: An anchor position can be stored or overwritten from any operating mode except route record mode.

To store an anchor location, press and hold any of the numbered **memory** buttons for two seconds. The unit will emit a tune to indicate that the anchor position has been stored successfully.

Stored anchor positions cannot be erased, but you can overwrite (record over) them. A stored anchor position can be overwritten by simply storing a new anchor position to the desired **memory** button.

Recalling a Stored Anchor Position

NOTE: A stored anchor position can be recalled from any operating mode.

To recall a stored anchor position, press and release the desired **memory** button. The trolling motor will emit an ascending chirp to indicate that a stored anchor position has been retrieved. If the selected anchor position button does not have a stored anchor position, or if the anchor location is over **one mile** away from your current location, the trolling motor will emit an error tone.

IMPORTANT: If the trolling motor loses the GPS signal while in any GPS mode, the trolling motor will emit an error tone and automatically return to manual mode.

IMPORTANT: When recalling a stored anchor position, the system will calculate a straight-line course from your current position to the selected anchor position. Ensure that there are no obstructions to navigation between your location and the selected anchor position—the system will recall an anchor point even if obstructions are present. If obstructions are encountered, navigate around them by operating in manual mode.

PRODUCT INSTALLATION AND OPERATION

⚠ WARNING

Avoid serious injury from colliding with other boats, running aground, or striking objects in the water. The Pinpoint GPS system cannot detect other boats, shallow water, or objects in the water. Always beware of possible obstructions to navigation when operating in any Pinpoint GPS mode.

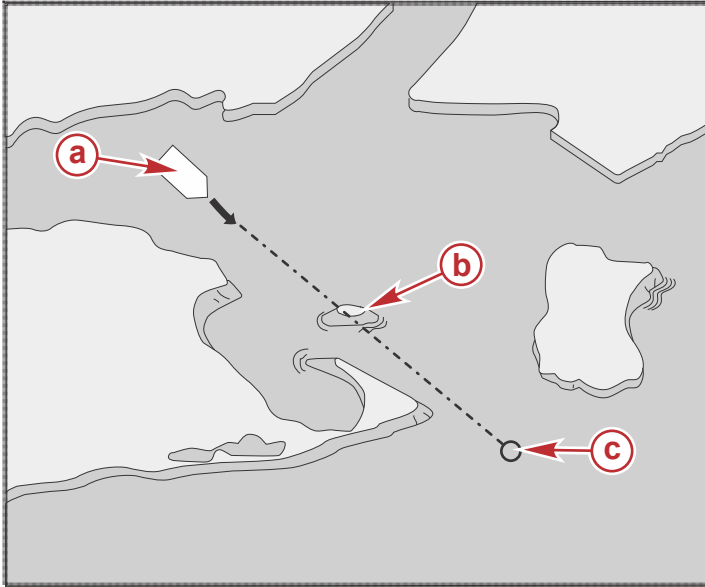

54421

Course shown has an obstruction to navigation

- a** - Current position of the boat
- b** - Obstruction to navigation
- c** - Selected anchor position

HEADING LOCK MODES OF OPERATION

The Pinpoint GPS system is capable of operating in two different heading lock modes. These modes are:

- Heading lock—course mode (default mode)
- Heading lock—compass mode

When **heading lock—course mode** is selected, the trolling motor will achieve lock and navigate along the trolling motor's heading, and compensate for current, tide, and wind conditions. While in this mode, the operator can adjust the speed and the heading by using the handheld remote. This is the default heading lock mode.

PRODUCT INSTALLATION AND OPERATION

When **heading lock—compass mode** is selected, the trolling motor will drive the boat along the trolling motor's compass heading. The boat will drift with the wind, tide, and current, but the trolling motor will maintain a constant compass heading. The operator can adjust the speed and the heading by using the handheld remote.

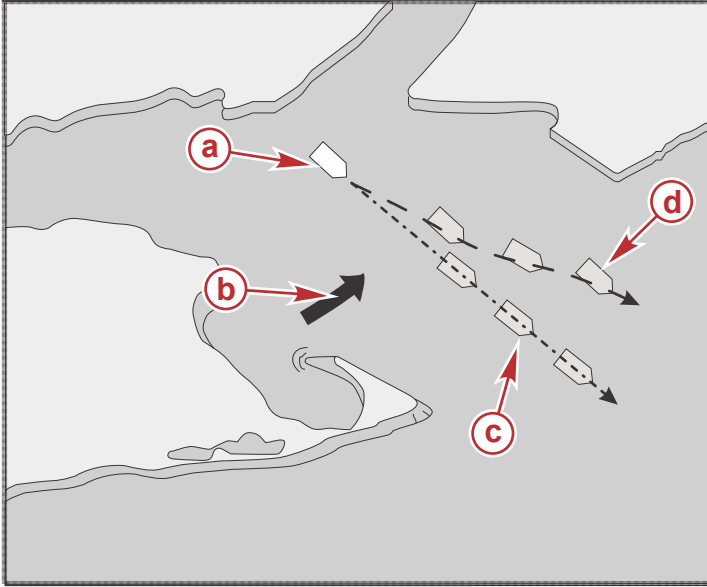

61241

- a** - Current position of the boat
- b** - Direction of wind or current
- c** - Boat traveling in heading lock—course mode (adjusting for the wind, tide, and current)
- d** - Boat traveling in heading lock—compass mode (trolling motor maintains a constant heading, boat drifts with the wind, tide, and current)

Both heading lock modes offer advantages to the angler. You can tailor the bait presentation depending on the species of fish, type of bait, underwater terrain, structures, water depth, or environmental conditions. MotorGuide recommends that you experiment with each heading lock mode in different conditions to learn what works best for you.

The operator can toggle between either heading lock mode. Refer to the following procedures for operating instructions and how to toggle between each mode.

PRODUCT INSTALLATION AND OPERATION

OPERATING IN HEADING LOCK—COURSE MODE

When **heading lock—course mode** is selected, the trolling motor will lock in and navigate along the trolling motor's heading, while compensating for current, tide, and wind conditions. While in this mode, the operator can adjust the speed and the heading by using the handheld remote. This is the default heading lock mode.

▲ WARNING

Avoid serious injury from colliding with other boats, running aground, or striking objects in the water. The Pinpoint GPS system cannot detect other boats, shallow water, or objects in the water. Always beware of possible obstructions to navigation when operating in any Pinpoint GPS mode.

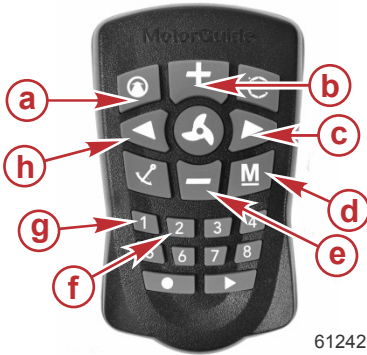

- a - Heading lock
- b - Increase speed (+)
- c - Right turn
- d - Manual mode
- e - Decrease speed (-)
- f - Button 2
- g - Button 1
- h - Left turn

61242

Heading Lock—Course Mode Operation

IMPORTANT: If the trolling motor loses the GPS signal while in a heading lock mode, the trolling motor will emit an error tone, automatically return to manual mode, and continue running at the selected speed.

If Cruise control was operating while in a heading lock mode and the GPS signal is lost, the trolling motor will emit an error tone, automatically return to manual mode, and the trolling motor will stop.

To operate the trolling motor in heading lock—course mode:

1. Steer the trolling motor so it is pointing in the desired direction of travel.
2. Press the **heading lock** button on the handheld remote.

The trolling motor will drive the boat along the chosen heading, and will automatically steer to compensate for wind, current, or tides to maintain course. The trolling motor will emit an ascending chirp to indicate its status in heading lock—course mode, and the GPS status indicator light will blink slowly.

PRODUCT INSTALLATION AND OPERATION

The trolling motor will drive the bow of the boat along this course, while the boat itself may be askew to the direction of travel due to current, tide, or wind conditions. In heading lock—course mode, the trolling motor will automatically steer to maintain course, and motor speed is user-selectable. The operator can use the left turn and right turn buttons to navigate around obstacles. In extreme current or wind conditions, it may be necessary to increase the motor speed to maintain the desired heading.

To exit heading lock mode, press the **heading lock** button or the **manual mode** button. The trolling motor will emit a descending chirp and the GPS status indicator light will stop blinking.

Adjusting Motor Speed

If a heading lock mode is selected from manual mode, the trolling motor will run at the last selected speed. The motor speed can be adjusted by pressing the **increase speed (+)** button or **decrease speed (-)** button. The trolling motor will emit two beeps when the user tries to exceed the available motor speed limits.

Cruise control can be used while in either heading lock mode. Refer to **Using Cruise Control**.

Adjusting the Heading

While in a heading lock mode, the heading can be adjusted by pressing the **left turn** or **right turn** buttons on the handheld remote. The trolling motor will resume heading lock—course mode navigation based on the new trolling motor heading.

Changing the Heading Lock Mode

Heading lock—course mode is the default heading lock mode. To switch to heading lock—compass mode, press and hold the **manual mode** button, then press the **2, 1, 2** buttons in sequence. To switch back to heading lock—course mode, press and hold the **manual mode** button, then press the **2, 1, 1** buttons in sequence.

IMPORTANT: The Pinpoint GPS system will remember which heading lock mode was last used, and the next time the heading lock button is pressed, the trolling motor will operate that mode.

OPERATING IN HEADING LOCK—COMPASS MODE

When **heading lock—compass mode** is selected, the trolling motor will lock in the trolling motor's compass heading and drive the boat along that heading. The boat will drift with the wind, tide, and current, but the trolling motor will maintain a constant compass heading. The operator can adjust the speed and the heading by using the handheld remote.

PRODUCT INSTALLATION AND OPERATION

▲ WARNING

Avoid serious injury from colliding with other boats, running aground, or striking objects in the water. The Pinpoint GPS system cannot detect other boats, shallow water, or objects in the water. Always beware of possible obstructions to navigation when operating in any Pinpoint GPS mode.

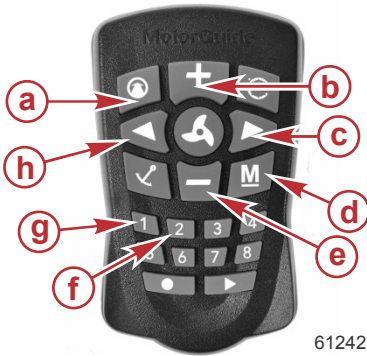

- a - Heading lock
- b - Increase speed (+)
- c - Right turn
- d - Manual mode
- e - Decrease speed (-)
- f - Button 2
- g - Button 1
- h - Left turn

61242

Heading Lock—Compass Mode Operation

IMPORTANT: If the trolling motor loses the GPS signal while in a heading lock mode, the trolling motor will emit an error tone, automatically return to manual mode, and continue running at the selected speed.

If cruise control was operating while in a heading lock mode and the GPS signal is lost, the trolling motor will emit an error tone, automatically return to manual mode, and the trolling motor will stop.

To operate the trolling motor in the heading lock—compass mode:

1. Steer the trolling motor so that it is pointing in the desired direction of travel.
2. Press the **heading lock** button on the handheld remote. The trolling motor will emit an ascending chirp, indicating it's status in heading lock—course mode.

IMPORTANT: To operate heading lock—compass mode for the first time, press and hold the manual mode button, then press the 2, 1, 2 buttons in sequence.

The trolling motor will maintain a constant compass heading, but the boat will drift with the wind, tide, and current. The operator can adjust the speed and the heading by using the handheld remote. In extreme current or wind conditions, it may be necessary to increase the motor speed to maintain the desired heading.

To exit heading lock—compass mode, press the **heading lock** button or the **manual mode** button. The trolling motor will emit a descending chirp and the GPS status indicator light will stop blinking.

PRODUCT INSTALLATION AND OPERATION

To switch back to heading lock—course mode, press and hold the **manual mode** button, then press the **2, 1, 1** buttons in sequence.

Adjusting Motor Speed

If a heading lock mode is selected from manual mode, the trolling motor will run at the last selected speed. The motor speed can be adjusted by pressing the **increase speed (+)** button or **decrease speed (-)** button. The trolling motor will emit two beeps when the user tries to exceed the available motor speed limits.

Cruise control can be used while in either heading lock mode. Refer to **Using Cruise Control**.

Adjusting the Heading

While in a heading lock mode, the heading can be adjusted by pressing the **left turn** or **right turn** buttons on the handheld remote. The trolling motor will resume heading lock—course mode navigation based on the new trolling motor heading.

Changing the Heading Lock Mode

Heading lock—course mode is the default heading lock mode. To switch to heading lock—compass mode, press and hold the **manual mode** button, then press the **2, 1, 2** buttons in sequence. To switch back to heading lock—course mode, press and hold the **manual mode** button, then press the **2, 1, 1** buttons in sequence.

IMPORTANT: The Pinpoint GPS system will remember which heading lock mode was last used, and the next time the heading lock button is pressed, the trolling motor will operate that mode.

OPERATING IN ROUTE MODE

Route mode has the ability to store and recall user-defined routes. These routes can be recorded and recalled by the user from any operating mode.

PRODUCT INSTALLATION AND OPERATION

⚠ WARNING

Avoid serious injury from colliding with other boats, running aground, or striking objects in the water. The Pinpoint GPS system cannot detect other boats, shallow water, or objects in the water. Always beware of possible obstructions to navigation when operating in any Pinpoint GPS mode.



- a - Memory buttons (1–8)
- b - Route playback
- c - Route record

53021

⚠ CAUTION

Avoid injury or property damage due to unintended operation. Certain objects—especially magnetic metal objects, such as anchors—can affect the GPS system if they are within or passing through the magnetic field surrounding the trolling motor. Objects obstructing the GPS signal can also have a negative effect on system operation. Be mindful of objects close to the trolling motor, and use care when operating the trolling motor in a GPS-guided mode.

Storing and Overwriting a Route

A route can be stored from any mode by pressing the **route record** button. The trolling motor will emit a tune when the **route record** button is pressed. Once the **route record** button is pressed, begin navigating along your desired course. You can switch between manual mode and heading lock mode at any time while recording a route. The trolling motor will emit one beep (and the GPS status indicator light will blink) for every 2 m (6.5 ft) travelled while recording. Press and hold any of the numbered **memory** buttons to stop recording and store the route to the selected **memory** button. The trolling motor will emit a tune to confirm that it has stored the route. The trolling motor can store up to eight routes, each up to 6.4 km (4 miles) in length.

Stored routes cannot be erased, but you can overwrite (record over) them. Overwriting a stored route is accomplished using the same procedure as storing a new route.

PRODUCT INSTALLATION AND OPERATION

Recalling a Stored Route

A stored route can be recalled while operating in any mode by pressing the **route playback** button, then pressing the desired **memory** button. The trolling motor will emit an ascending chirp to indicate that the route has been successfully recalled.

IMPORTANT: When recalling a stored route, the system will calculate a straight-line course from your current position to the nearest point on the recalled route. Ensure that there are no obstructions to navigation between your current position and the recalled route. The system will recall a stored route even if obstructions are present. If obstructions are encountered, navigate around them by operating in manual mode.

▲ WARNING

Avoid serious injury from colliding with other boats, running aground, or striking objects in the water. The Pinpoint GPS system cannot detect other boats, shallow water, or objects in the water. Always beware of possible obstructions to navigation when operating in any Pinpoint GPS mode.

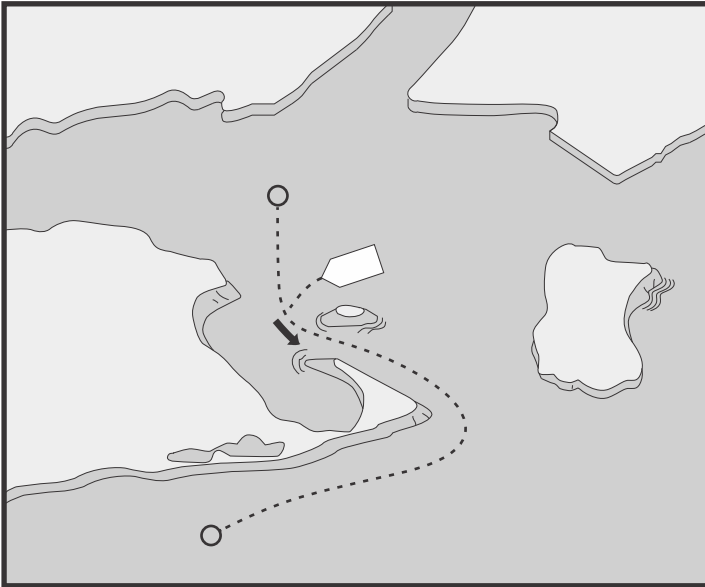

53022

Recalling a stored route—beware of possible obstructions to navigation

If the selected memory position is empty, or if the boat is over 1.6 km (1 mile) from a point on the selected route, the trolling motor will emit an error tone and exit the route mode.

PRODUCT INSTALLATION AND OPERATION

IMPORTANT: If the trolling motor loses the GPS signal while in any GPS mode, the trolling motor will emit an error tone and automatically return to manual mode.

⚠ CAUTION

Avoid injury or property damage due to unintended operation. Certain objects—especially magnetic metal objects, such as anchors—can affect the GPS system if they are within or passing through the magnetic field surrounding the trolling motor. Objects obstructing the GPS signal can also have a negative effect on system operation. Be mindful of objects close to the trolling motor, and use care when operating the trolling motor in a GPS-guided mode.

When recalling a stored route, the trolling motor will navigate to the nearest point on the route, then travel to the most distant end from the boat's current position. At any time while traveling along a stored route, the direction of travel can be reversed by recalling the stored route again. Once you have reached the end of a stored route, the trolling motor will set anchor in the anchor mode and will emit an ascending chirp to indicate that the boat has arrived at the end of the stored route.

USING CRUISE CONTROL

Cruise control can be activated while in heading lock mode or route playback mode to maintain a constant trolling speed. It will automatically adjust the motor speed to correct for current and wind conditions to maintain a constant speed.

⚠ WARNING

Avoid serious injury from colliding with other boats, running aground, or striking objects in the water. The Pinpoint GPS system cannot detect other boats, shallow water, or objects in the water. Always beware of possible obstructions to navigation when operating in any Pinpoint GPS mode.

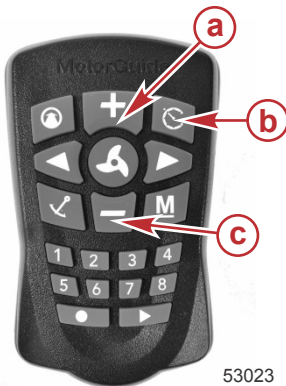

- a** - Increase speed (+)
- b** - Cruise control
- c** - Decrease speed (-)

PRODUCT INSTALLATION AND OPERATION

▲ CAUTION

Avoid injury or property damage due to unintended operation. Certain objects—especially magnetic metal objects, such as anchors—can affect the GPS system if they are within or passing through the magnetic field surrounding the trolling motor. Objects obstructing the GPS signal can also have a negative effect on system operation. Be mindful of objects close to the trolling motor, and use care when operating the trolling motor in a GPS-guided mode.

Setting Cruise Control

While in heading lock mode or route recall mode, you can set the cruise control by pressing the **cruise control** button. The trolling motor will emit one ascending chirp to indicate that the cruise control has been activated. The system will automatically set a trolling speed of 1.0 mph (1.6 kph) and will compensate for current and wind conditions to maintain this speed. Pressing the **cruise control** button again will turn the cruise control off, indicated by a descending chirp from the trolling motor.

While cruise control is turned on, the GPS speed over ground can be adjusted by pressing the **increase speed (+)** or **decrease speed (-)** buttons. Pressing either button once will adjust the speed by 0.1 mph (0.16 kph) accordingly. For example, to set the cruise control at 1.3 mph (2.1 kph), press the **cruise control** button, then press the **increase speed (+)** button three times.

IMPORTANT: If the trolling motor loses the GPS signal while in any GPS mode, the trolling motor will emit an error tone and automatically return to manual mode.

IMPORTANT: Cruise control function can be affected by the quality of the GPS signal. Obstructions such as bridges, mountains, and trees, or environmental conditions such as thunderstorms may affect the GPS signal strength and possibly cause the trolling motor to operate erratically.

PRODUCT INSTALLATION AND OPERATION

SELECTING THE AUDIO MODE

The Pinpoint GPS system has three user-selectable audio modes to choose from. These audio modes provide audible confirmation of selected modes, speeds, and button selections.

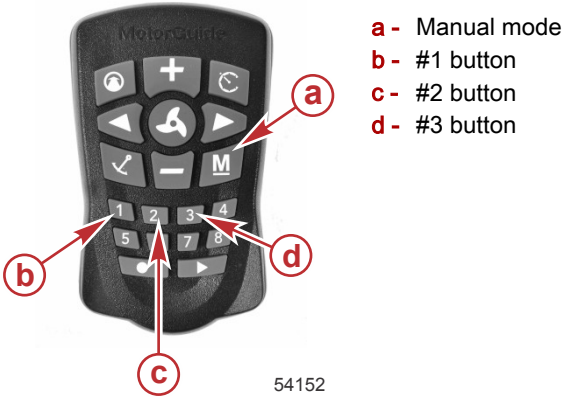

- a - Manual mode
- b - #1 button
- c - #2 button
- d - #3 button

Audio mode 1 can be selected by pressing and holding the **manual mode** button, then pressing **1, 3, 1**.

Audio mode 2 can be selected by pressing and holding the **manual mode** button, then pressing **1, 3, 2**.

Audio mode 3 can be selected by pressing and holding the **manual mode** button, then pressing **1, 3, 3**.

Condition	Audio Pattern	Audio Mode 1 (Default)	Audio Mode 2	Audio Mode 3
Startup	1 beep	Yes	Yes	Yes
Remote learn confirmation	Low tune	Yes	Yes	Yes
User invalid command (No GPS fix)	Error beep	Yes	Yes	Yes
GPS fix acquired	High tune	Yes	Yes	-
Loss of GPS fix	Error	Yes	Yes	-
Speed + (when less than maximum speed)	Short beep	-	Yes	-
Speed + (at maximum speed)	2 beeps	Yes	Yes	-
Speed - (when greater than speed level 0)	Short beep	-	Yes	-
Speed - (at speed 0)	2 beeps	Yes	Yes	-

PRODUCT INSTALLATION AND OPERATION

Condition	Audio Pattern	Audio Mode 1 (Default)	Audio Mode 2	Audio Mode 3
Pressing the propeller on/off button to turn the propeller on	2 beeps up	Yes	Yes	–
Pressing the propeller on/off button to turn the propeller off	2 beeps down	Yes	Yes	–
Momentary propeller	None	–	–	–
Record Route Enable	Tune	Yes	Yes	–
Record Route Save	Tune	Yes	Yes	–
Recall Route Enable	Chirp up	Yes	Yes	–
Recall Route Disable	Chirp down	Yes	Yes	–
Reach End of Route	Chirp up	Yes	Yes	–
Heading Lock Enable	Chirp up	Yes	Yes	–
Heading Lock Disable	Chirp down	Yes	Yes	–
Cruise Control Enable	Chirp up	Yes	Yes	–
Cruise Control Disable	Chirp down	Yes	Yes	–
Anchor Enable	Chirp up	Yes	Yes	–
Anchor Disable	Chirp down	Yes	Yes	–
Record Anchor Position	Tune	Yes	Yes	–
Anchor Recall	Chirp up	Yes	Yes	–
Recalling an anchor point or route more than one mile away	Error	Yes	Yes	Yes

Connecting the Pinpoint GPS System to Your Fish Finder

To connect the Pinpoint GPS system to your fish finder, please refer to www.motorguide.com for further information.

MAINTENANCE AND STORAGE

Trolling Motor Care

To keep your trolling motor in the best operating condition and retain its dependability, your trolling motor must receive periodic inspections and maintenance. Keep it maintained properly to ensure the safety of you and your passengers.

WARNING

Neglecting to inspect, maintain, or repair your trolling motor can result in product damage or serious injury or death. Do not perform maintenance or service on your trolling motor if you are not familiar with the correct service and safety procedures.

Record all maintenance performed and save maintenance work orders and receipts.

SELECTING REPLACEMENT PARTS

Use only original MotorGuide replacement parts.

Inspection and Maintenance Schedule

BEFORE EACH USE

- Inspect for loose or corroded wiring connections.
- Check the tightness of the battery cable connections. Nylock nuts are recommended for securing the battery cables to their terminals.
- Check the tightness of the propeller nut.
- Check the propeller blades for damage.
- Check the tightness of the mount to the deck of the boat.

AFTER EACH USE

- Disconnect the battery cables from the power source or unplug the motor from the boat.
- Check each side of the propeller and propeller shaft for debris such as weeds and fishing line. Remove all debris.
- Check the tightness of the propeller nut.
- Wash the trolling motor with clean water and a mild soap such as Attwood® Premium Boat Wash to remove dirt and dust that may scratch the surface.

IMPORTANT: Do not use harsh cleaners such as bleach or citrus cleaners to clean the trolling motor. These cleaners can damage the finish on the trolling motor.

IMPORTANT: Do not power wash the trolling motor.

EVERY 100 HOURS OF USE OR ANNUALLY (WHICHEVER OCCURS FIRST)

1. Apply 2-4-C with PTFE to the depth collar knob screw threads.

MAINTENANCE AND STORAGE

NOTE: 2-4-C with PTFE is a marine grease available at marine supply stores and your MotorGuide dealer.

Description	Where Used
2-4-C with PTFE	Depth collar knob screw threads

2. Remove the side panels by removing the two screws on each side of the mount. Gently pull the cover away from the mount and towards the foot release lever.



- a** - Depth collar knob screw threads
- b** - Screws securing the side panel
- c** - Foot release lever

3. Apply 2-4-C with PTFE to the slot on the foot release lever linkage on both sides of the deck mount. Press the foot release lever and apply more 2-4-C with PTFE to the slot, equally distributing the grease along the length of the slot.
4. Apply 2-4-C with PTFE to the front and rear hooks on both sides of the deck mount.

MAINTENANCE AND STORAGE

Description	Where Used
2-4-C with PTFE	Slot on the foot release lever linkage, and front and rear hooks on both sides of the deck mount

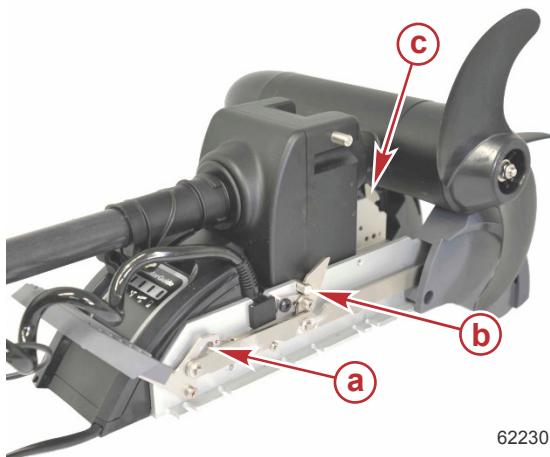

62230

Lubricate the slots and hooks on both sides of the deck mount

- a - Slot
- b - Front hook
- c - Rear hook

IMPORTANT: Never use an aerosol lubricant or solvent-based lubricant to grease or oil any part of the trolling motor. Many aerosol lubricants contain harmful propellants that can cause damage to various parts of the trolling motor.

5. Install the side panels onto the deck mount and tighten the screws.
6. Check the tightness of the mounting screws, nuts, and other fasteners.
7. Inspect the battery. Refer to **Battery Inspection**.

Storage Preparation

The major consideration in preparing your trolling motor for storage is to protect it from corrosion and damage caused by freezing of trapped water. It is also recommended that batteries are disconnected prior to storage and that the batteries are stored indoors in a dry location during long-term storage. The batteries should also be removed from the handheld remote and wireless foot pedal for long-term storage.

Refer to the **Inspection and Maintenance Schedule** and complete the appropriate care instructions to prepare your trolling motor for storage. Store the trolling motor in a dry location where it will not be affected by temperatures below -29°C (-20°F).

MAINTENANCE AND STORAGE

IMPORTANT: Trolling motors stored in temperatures below 0 °C (32 °F) should be operated slowly for a minimum of 15 minutes before going above 30% throttle.

Battery Inspection

The battery should be inspected at periodic intervals to ensure proper trolling motor operation.

IMPORTANT: Read the safety and maintenance instructions that accompany your battery.

1. Ensure that the battery is secured to the vessel.
2. Ensure that the battery cable terminals are clean, tight, and correctly installed.
3. Ensure that the battery is equipped with a battery box to prevent accidental shorting of the battery terminals.

OWNER SERVICE ASSISTANCE

Frequently Asked Questions and Troubleshooting

This section is focused on questions and troubleshooting advice for the Pinpoint GPS. Refer to **Owner Service Assistance** in the **Xi5 Wireless Owners and Installation Manual** for trolling motor troubleshooting assistance.

Why does the trolling motor emit a tune a few moments after I power it up?

The GPS has acquired a fixed position. Refer to the **Pinpoint GPS Startup** section of this manual.

When I recall a stored anchor position, the trolling motor emits an error tone and will not navigate to my anchor position. Why is that?

The anchor position you chose to recall is over one mile away from your current location, or the system has not acquired a fixed GPS position. Refer to the **Operating in Anchor Mode** section of this manual.

When I try to recall a stored route, the trolling motor emits an error tone and will not navigate along my route. Why is that?

You are more than one mile away from the nearest point on the selected route, or the system has not acquired a fixed GPS position. Refer to the **Operating in Route Mode** section of this manual.

Why did the handheld remote stop working?

Several conditions can cause the handheld remote to stop working. Verify that the trolling motor is locked in the deployed position. Cycle the trolling motor power off, then back on. Finally, check the battery in the handheld remote and replace it if necessary. Immediately after a command is given from any remote, the motor will only accept a command from that particular remote. After going 30 seconds without receiving a command, the motor will be open to receiving commands from any synced remote.

The Pinpoint GPS will not store an anchor point, recall a route, or hold a heading lock. Why is that?

The GPS has not acquired a fixed GPS position. The GPS system can take between 30 seconds to 10 minutes to acquire a fixed GPS position. Listen for a three-beep tone, and also look for the GPS status indicator light to illuminate, indicating that the system has acquired a fixed GPS position. Also, verify that no obstructions are overhead (such as bridges, buildings, large trees, mountain ranges, thunderstorms, etc.) blocking the GPS antenna's view of the sky overhead.

After selecting a mode, the trolling motor emits an error tone, then does nothing. What is wrong?

The GPS has not acquired a fixed GPS position, the trolling motor battery voltage is low, or there is a loose battery connection. Listen for a three-beep tone, and also look for the GPS status indicator light to illuminate, indicating that the system has acquired a fixed GPS position. Check all connections. Charge the batteries and test for a bad battery if the trouble persists.

OWNER SERVICE ASSISTANCE

Service Assistance

Your satisfaction with your product is very important to us. If you have a problem or question about your motor, contact your dealer or any certified MotorGuide Service Center. For more service assistance information, refer to **Warranty Information**.

The following information will be needed by the service office:

- Your name and address
- Daytime telephone number
- Model and serial number of your trolling motor
- Proof of purchase or registration verification
- Nature of problem

Mercury Marine Service Offices

For assistance, call, fax, or write. Please include your daytime telephone number with mail and fax correspondence.

United States, Canada		
Telephone	English +1 920 929 5040 Français + 905 636 4751	Mercury Marine W6250 Pioneer Road
Fax	English +1 920 929 5893 Français +1 905 636 1704	P.O. Box 1939 Fond du Lac, WI 54936-1939
Website	www.mercurymarine.com	

Australia, Pacific		
Telephone	+61 3 9791 5822	Brunswick Asia Pacific Group 41-71 Bessemer Drive Dandenong South, Victoria 3175 Australia
Fax	+61 3 9706 7228	

Europe, Middle East, Africa		
Telephone	+32 87 32 32 11	Brunswick Marine Europe Parc Industriel de Petit-Rechain B-4800 Verviers, Belgium
Fax	+32 87 31 19 65	

Mexico, Central America, South America, Caribbean		
Telephone	+1 954 744 3500	Mercury Marine 11650 Interchange Circle North Miramar, FL 33025 U.S.A.
Fax	+1 954 744 3535	

OWNER SERVICE ASSISTANCE

Asia, Singapore, Japan		
Telephone	+65 65466160	Brunswick Asia Pacific Group
Fax	+65 65467789	T/A Mercury Marine Singapore Pte Ltd 29 Loyang Drive Singapore, 508944